

Customer/Wholesaler:	Date:	Job Name:	Model Specified:	Quantity:
Contractor:		Architect/Engineer:		

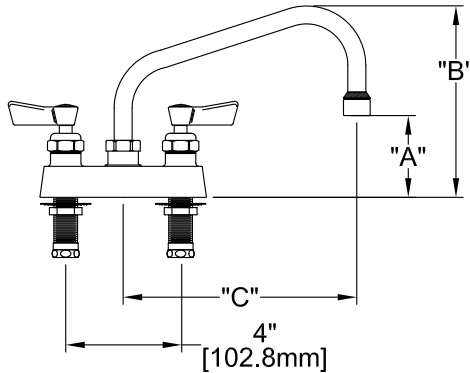

FOOTPRINT:

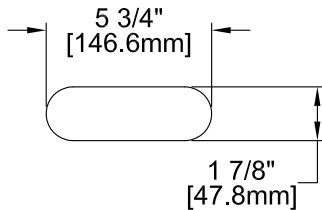

MODEL	DIM "A"	DIM "B"	DIM "C"
3510	2-3/8" [60.3mm]	6" [152.4mm]	6" [152.4mm]
3511	2-5/8" [66.7mm]	6-1/2" [165.1mm]	8" [203.2mm]
3512	3-1/4" [82.6mm]	7" [177.8mm]	10" [254.0mm]
3513	3-7/8" [98.4mm]	7-1/2" [190.5mm]	12" [304.8mm]
3514	4-1/2" [114.3mm]	8-3/8" [212.7mm]	14" [355.6mm]
1635	5-1/8" [130.2mm]	9" [228.6mm]	16" [406.4mm]

MODEL:

- 3510 FAUCET 4DLH 06SS
- 3511 FAUCET 4DLH 08SS
- 3512 FAUCET 4DLH 10SS
- 3513 FAUCET 4DLH 12SS
- 3514 FAUCET 4DLH 14SS
- 1635 FAUCET 4DLH 16SS

OPTIONS OR MODIFICATIONS:

- OTHER _____

FEATURES

- * 4" C/C DECK MOUNT
- * SWIVELLING SEAT DISKS
- * HOT SIDE STEM - RIGHT HAND
- * COLD SIDE STEM - LEFT HAND
- * STAINLESS STEEL SEATS
- * STAINLESS STEEL SEAT SCREWS
- * STAINLESS STEEL HANDLE SCREWS
- * 1/2" SLIP JOINT

SYSTEM LIMITS

- * TEMP: 40°F MIN. TO 160°F MAX.
- * PRESSURE: 200 PSI MAX. STATIC
- * 2.20 GPM AT 60 PSI (8.3L/min @ 410 kPa)

SHIPPING WEIGHT

- * 4.25 LBS

PRODUCT COMPLIANCE:

- * ASME A112.18.1 / CSA B125.1
- * NSF 61 - Section 9
- * NSF 372 (Low Lead Content)

ROUGH-IN:

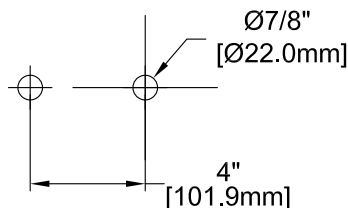

Replacement Parts for Deck Mount Faucets

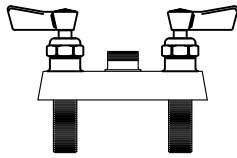

3500
CONTROL VALVE



2000-7500
SCREW



2000-8000
RED BUTTON
AND
2000-8001
BLUE BUTTON



LEVER HANDLE

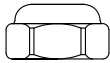

2000-3002
BIBB CAP



73657
DUCK GASKET



2000-5000
WASHER

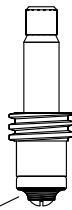

3000-0010
LH SWIVEL STEM
OR
3000-0011
RH SWIVEL STEM

2000-5003
SEAT WASHER

1000-7502
SCREW



73521
LUBE

2000-0002
LEVER HANDLE KIT

3000-0000
RH SWIVEL STEM
REPAIR KIT
OR
3000-0001
LH SWIVEL STEM
REPAIR KIT

3967
16" SWING SPOUT

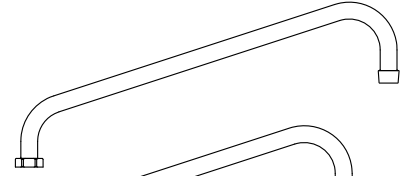

3964
14" SWING SPOUT

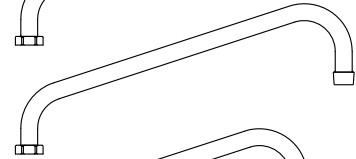

3963
12" SWING SPOUT

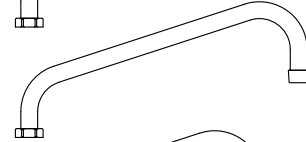

3962
10" SWING SPOUT

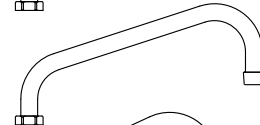

3961
8" SWING SPOUT

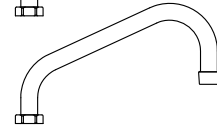

3960
6" SWING SPOUT

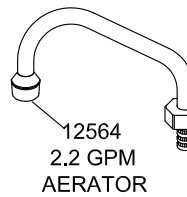
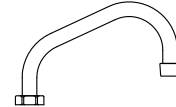

12564
2.2 GPM
AERATOR

73684
SPOUT NUT



20020
SNAP RING



1600-5000
SPOUT
O-RING



73521
LUBE



19119
SWIVEL SPOUT
RETRO-FIT KIT

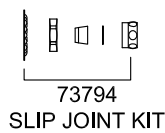

73794
SLIP JOINT KIT